

**SPECIFICATIONS:**

POSTS RAILS: NORTH AMERICAN PRODUCED EXTRUDED  
 PICKETS PRIME MARINE ALUMINUM 6061-T6

FINISH: SEVEN STAGE ARCHITECTURALLY CERTIFIED  
 PRETREATMENT AS PER AAMA 2604.  
 SUPER DURABLE ELECTROSTATICALLY APPLIED  
 POWDER COAT - MIN THICKNESS 2.5 mils

POSTS: 51mm x 51mm (2"x2"), .125WALL STANDARD  
 (.188 WALL AVAILABLE)

POST CAPS: PYRAMID, BALL, SPIRE OR ACORN

RAILS: 25mm x 25mm (1" x 1"),  
 .125WALL (top and bottom)  
 .180WALL (sidewall)

UPRIGHTS: 25mm x 25mm (1" x 1") .065WALL

PICKETS: 16mm x 16mm (5/8" x 5/8"), .080 WALL

INFILL: 89mm SCROLLS

WELDS: ALUMINUM - FULL TACK BOTH SIDES OF PICKET

COLOUR: STANDARD COLOURS ARE BLACK, SEMI-BLACK,  
 BROWN, GREEN WHITE & FOREST GREEN  
 CUSTOM COLOURS AVAILABLE UPON REQUEST

**AVAILABLE GATE HEIGHTS:**

762mm	(30")	
914mm	(36")	
1067mm	(42")	
1219mm	(48")	
1524mm	(60")	SHOWN
1829mm	(72")	

**FITTINGS**

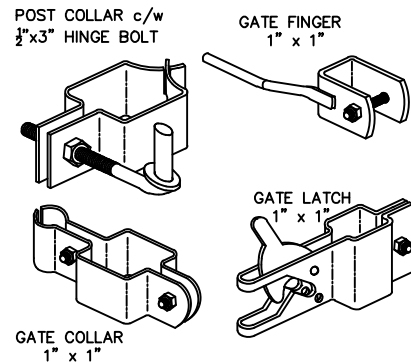

**SECTION A-A**

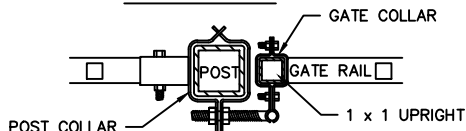

**SECTION B-B**

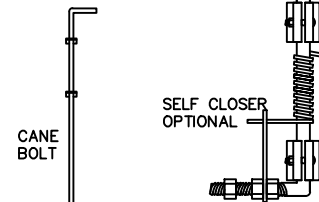
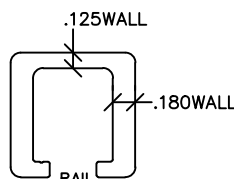

COMMENTS: DOUBLE SWING GATE



TITLE

**IRON EAGLE I ALUMINUM SERIES  
 STYLE 2910 DOUBLE SWING GATE**

DRAWING No.

**A2910-DG**

CHK'D

DATE: JAN 12, 2018