

NOTE 1. SPEAR PICKET TOP (IE-1)



OPTION: FLEUR DE LIS (IE-2)



NOTE 2. 89mm DIA. (3 1/2") CAST IRON RING



OPTION: 89mm DIA. (3 1/2") CAST IRON DIAMOND



GATE TOP OPTIONS

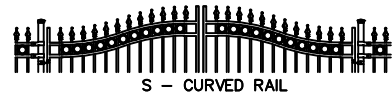
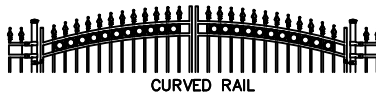
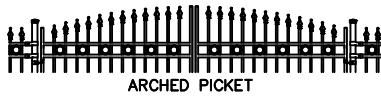

SPECIFICATIONS:

POSTS: GALVALUME™ COLD FORMED STEEL TUBING & PICKETS COATED INTERIOR & EXTERIOR

RAILS: ZAM™ COATED COLD FORMED TUBING (Zinc, Aluminum, Magnesium) COATED INTERIOR & EXTERIOR

FINISH: CHROMATE CONVERSION COATING ELECTROSTATICALLY APPLIED THERMALLY BONDED POLYESTER POWDER COATING MINIMUM FILM THICKNESS 2.5 mils

POSTS: 51mm x 51mm (2"x2"), 14 OR 16GA.

POST CAPS: PYRAMID, BALL, SPIRE OR ACORN

RAILS: 25mm x 25mm (1" x 1"), 14GA.

UPRIGHTS: 25mm x 25mm (1" x 1"), 16GA

PICKETS: 16mm x 16mm (5/8" x 5/8"), 18GA. CAST SPEAR (IE-1) OR FLEUR DE LIS (IE-2) TOPS (USE IE-1 UNLESS OTHERWISE NOTED)

INFILL: 89mm DIA. CAST IRON RING OR DIAMOND (USE RINGS UNLESS OTHERWISE NOTED)

WELDS: STAINLESS STEEL

COLOUR: STANDARD COLOURS ARE BLACK, SEMI-BLACK BROWN, GREEN, WHITE AND FOREST GREEN (CUSTOM COLOURS AVAILABLE UPON REQUEST)

AVAILABLE GATE HEIGHTS:

762mm (30")	
914mm (36")	
1067mm (42")	
1219mm (48")	
1524mm (60")	SHOWN
1829mm (72")	

FITTINGS

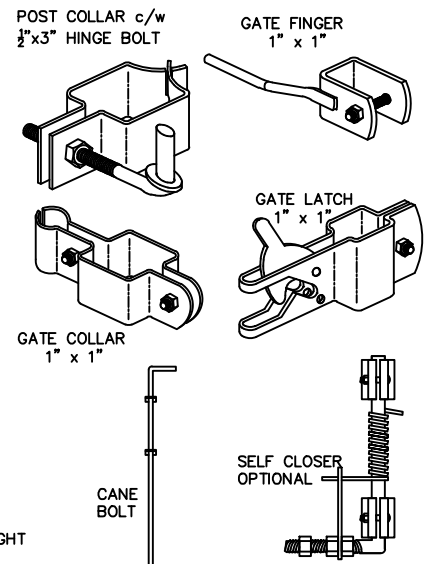

SECTION A-A

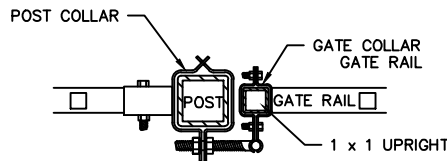

COMMENTS: DOUBLE SWING GATE



TITLE	IRON EAGLE I STYLE 2190 DOUBLE SWING GATE	DRAWING No. 2190-DG
CHK'D		DATE: JAN 12, 2018